

RESOL DeltaSol[®] M

Manual

for the professional

Installation

Operation

Commissioning

Fault localisation



Thanks for buying a RESOL.
Read this manual carefully to get the best performance from this unit.

DeltaSol[®] M

www.resol.de

Contents

Security instructions and imprint	2	3.2 Irradiation sensors	14
Technical data and functional survey	3	3.3 Flowmeter	14
Examples of application	4	3.4 Remote control	14
1. Installation	5	3.5 Outdoor temperature sensor	15
1.1 Mounting	5	4. Basics of operation	15
1.2 Electrical connection	6	4.1 Operating elements and display	15
1.2.1 Connection survey	6	4.2 Control lamps	15
1.2.2 Sensors	6	4.3 Menu structure	16
1.2.3 Acutators	7	4.4 Menu branch	17
1.2.4 Bus-connection	7	5. Functions and options	18
1.2.5 Power connection	8	6. Commissioning	29
2. Basic systems and hydraulic versions	8	6.1 Commissioning of the Controller	29
2.1 Survey of relay allocation	9	6.2 Set for use with Solar cell	29
2.2 Survey of sensor allocation	12	6.3 Balancing without flow meter V40	29
3. Sensors	14	6.4 Balancing with flow meter V40	29
3.1 Temperature sensors	14	7. Tips for fault localization	30

Imprint

This mounting- and operation manual including all parts is copyrighted. Another use outside the copyright requires the approval of RESOL - Elektronische Regelungen GmbH. This especially applies for copies, translations, micro films and the storage into electronic systems.

Editor: RESOL - Elektronische Regelungen GmbH

Important notice:

We took a lot of care over the texts and drawings of this manual and to the best of our knowledge and consent. As

faults can never be excluded, please note:

Your own calculations and plans under consideration of the current norms and DIN-directions should only be basis for your projects. We don't offer a guarantee for the completeness of the drawings and texts of this manual - they only represent some examples. They can only be used on own risk. No liability is assumed for incorrect, incomplete or false information and the resulting damages.

Errors and technical changes excepted

Security advice

Please carefully read the manual for mounting and installation before commissioning the controller. In this way damages to the system can be avoided. Please also note that the installation must be adapted to the conditions provided by the customer. The installation and operation must be executed according to the approved technical regulations. The regulations for prevention of industrial accidents of industrial injuries corporations must be observed. The improper use as well as the incorrect modification of installation and construction result in the exclusion of any kind of liability. The following technical rules must especially be considered:

DIN 4757, Part 1

Solar heating plants with water and water mixtures as heat transfer medium; Standards for safety regulations

DIN 4757, Part 2

Solar heating plants with organic heat transfer mediums; Standards for the safety regulations

DIN 4757, Part 3

Solar heating plants; solar panels; terms; safety regulations: checking of the shutdown temperature

DIN 4757, Part 4

Solar thermal plants; solar panels; determination of degree of efficiency, capacity of warmth and pressure drop.

European CE-standards are being developed presently:

PrEN 12975-1

Thermal solar plants and their components; collectors, part 1: general standards

PrEN 12975-2

Thermal solar plants and their components; collectors, part 2: test methods

PrEN 12976-1

Thermal solar plants and their components; prefabricated plants, part 1: general standards

PrEN 12976-2

Thermal solar plants and their components; prefabricated plants, part 2: test methods

PrEN 12977-1

Thermal solar plants and their components; user-specific fabricated plants, part 1: general standards

PrEN 12977-2

Thermal solar plants and their components; user-specific fabricated plants, part 2: test methods

PrEN 12977-3

Thermal solar plants and their components; user-specific fabricated plants, part 3: efficiency test of hot water tank

Scheme of the controller

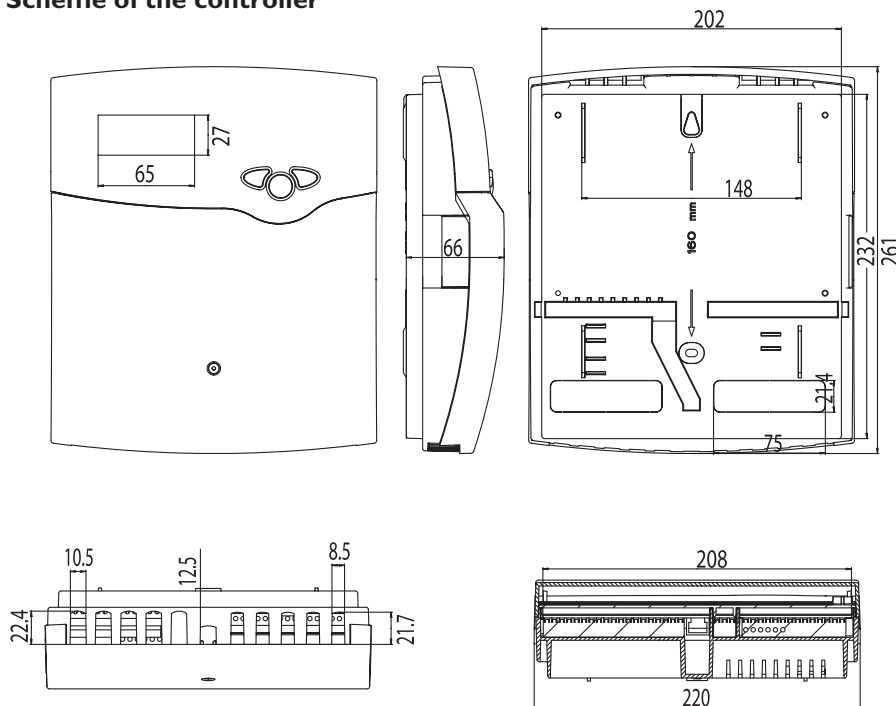

- Menu-driven text display
- 15 sensor inputs
- 9 relay outputs
- 7 basic solar systems
- add-on options and functions
- free allocation for temperature difference and thermostat function
- RESOL V-BUS and RS-232 interface
- parameterization and control of the system by RESOL service center software

Technical data DeltaSol® M

Housing:	plug-in plastic, PC-ABS and PMMA
Protection type:	IP 20 / DIN 40 050
Ambient temp.:	0 ... 40 °C
Size:	260 x 216 x 64 mm
Installation:	wall mounting, also suitable for mounting into patch panels
Display:	4-digit LC-text display (illuminated), menu-driven (multilingual), 2-coloured LED
Operation:	3 pushbuttons in the front of the housing
Functions:	Solar system controller for use in solar- and heating systems. Two integrated calorimeters and control of a weather-compensated heating circuit. Adjustable system parameter and add-on options (menu-driven), balance- and diagnostic functions, function control according to BAW-guidelines.
Sensor inputs:	12 temperature sensors Pt1000 or 11 sensors PT1000 and 1 remote control RTA11, 2 flowmeter RESOL V40 and 1 solar cell RESOL CS10.
Relay outputs:	9 relay outputs, 4 of them are standars ones, 4 semi-conductor relays and 1 potential-free relay.
Bus:	RESOL VBus, RS232

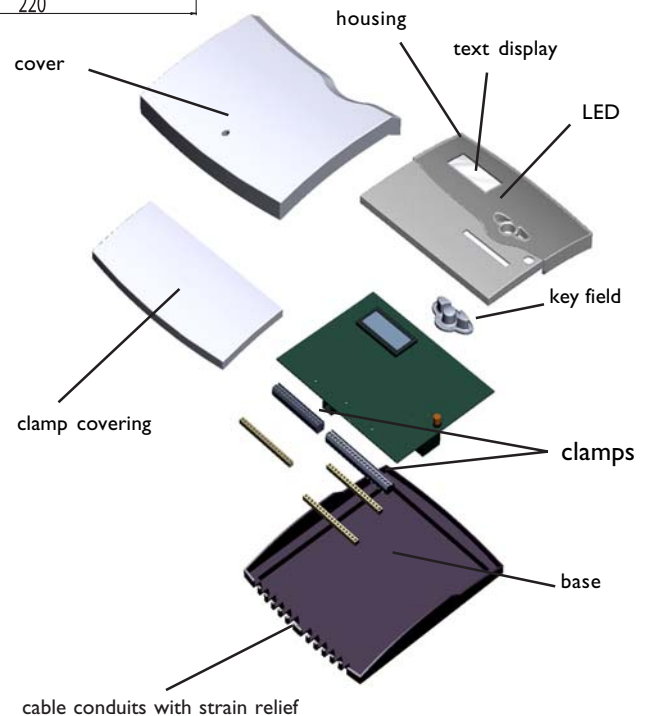

Power supply:	210 ... 250 V~, 50 ... 60 Hz
Power consumption:	6,3 (1) A 250 V~
Degree of pollution:	2
Rated impulse voltage:	2,5 kV
Ball pressure check:	75 °C
Mode of operation:	Typ 1.c



Electrostatic discharge can lead to damages of electronic components.



Attention high-voltage carrying components.

Examples of application DeltaSol® M

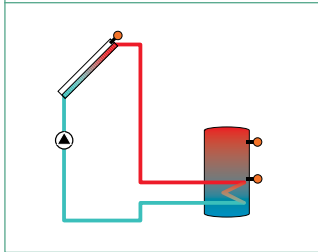
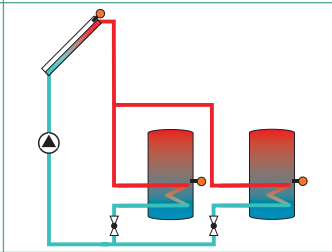
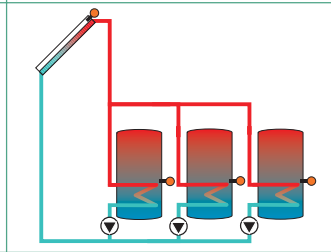
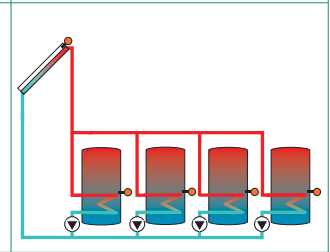
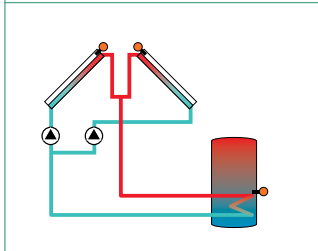
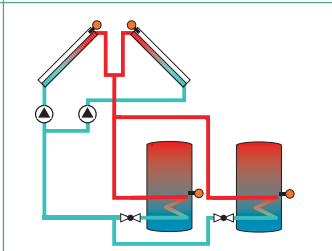
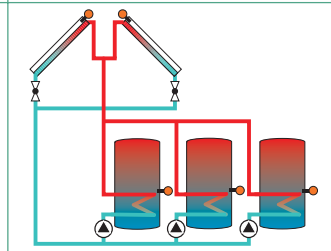
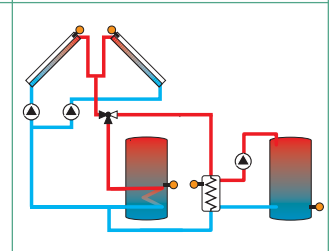
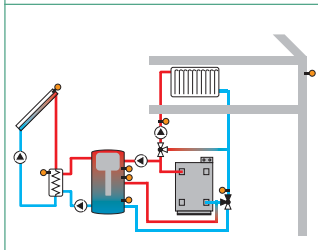
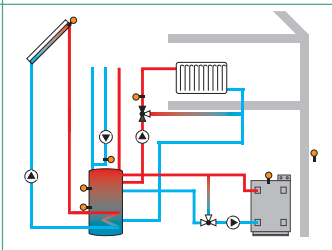
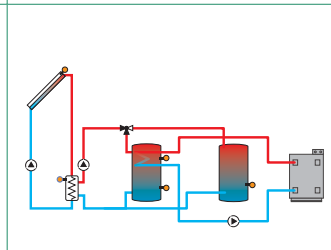
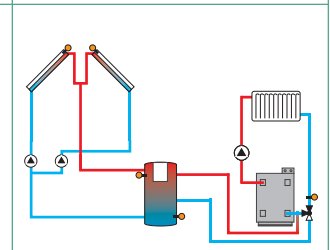
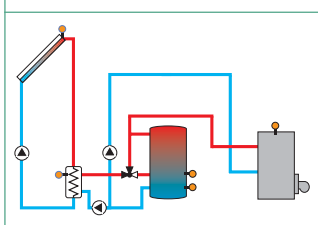
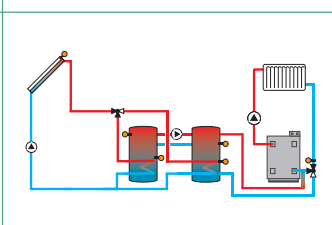
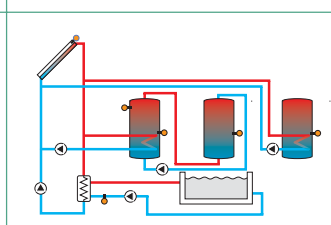
<p>Standard solar system with 1 store</p> 	<p>Standard solar system with 2 stores</p> 	<p>Standard solar system with 3 stores</p> 	<p>Standard solar system with 4 stores</p> 
<p>Standard solar system with east/west collectors and 1 store</p> 	<p>Standard solar system with east/west collectors and 2 stores</p> 	<p>Standard solar system with east/west collectors and 3 stores</p> 	<p>Standard solar system with east/west collectors, external heat exchanger and 2 stores</p> 
<p>Combined solar/heating system with external heat exchanger and combined store as well as reverse raising</p> 	<p>Combined solar/heating system with after-heating by solid fuel boiler and control of a circulation pump</p> 	<p>Solar system with external heat exchanger and 2 stores</p> 	<p>Solar system, 1 combined store with reverse raising (heating backup)</p> 
<p>Solar system with layered store, external heat exchanger and after-heating</p> 	<p>Solar system with 1 store, heating backup and heat exchange regulation for existing domestic water store</p> 	<p>Combined solar/swimming-pool system with heat exchange regulation for existing domestic water store</p> 	<p>The given examples only show a little choice of the possible applications. Further application examples can be found in the DeltaSol® M system collection. www.resol.de</p>

1. Installation

1.1 Mounting



Attention! Switch-off power supply before opening the housing!

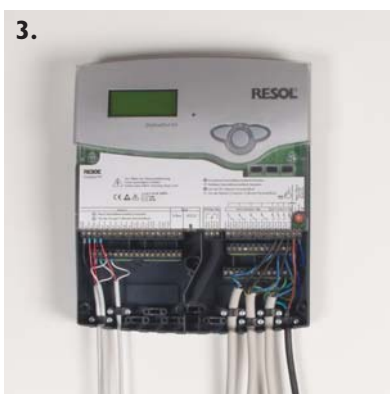

The unit must only be located internally. It is not suitable for installation in hazardous locations and should not be sited near to any electromagnetic field. The controller must additionally be equipped with an all-polar gap of at least 3 mm or with a gap according to the valid installation regulations, e.g. LS-switches or fuses. Please pay attention to a separate laying of the cable lines and installation of a power supply.

1. Unscrew the cross-recessed screw of the cover and remove it from the housing. Unscrew now the cross-recessed screws from the clamp cover and remove it.
2. Mark the upper fastening point on the underground and pre-mount the enclosed dowel and screw.
2. Hang up the housing at the upper fastening point and mark the lower fastening point on the underground (hole center distance 160 mm, see back of the base), afterwards fit the lower dowel. Hang up the housing at the top and fix it with the lower fastening screw.
3. Connect relay- and sensor cables as well as power cable according to clamp allocation and fix the cables with strain-relief.
4. Reinsert clamp cover and cover of the housing and fix them with cross-recessed screws.

Tip:

A cable conduit (e.g. 60 x 110 mm²) should be directly mounted below the controller in order to facilitate the connection of the cables and to guarantee a clear running of the cables. The cables must be brought into the terminal block with removed cable insulation.



Scope of accessory bag:

- 2x screws and dowels
- 1x spare fuse T6,3A
- 11x strain relief and screw
- 3x condenser 4,7 nF

1.2 Electrical wiring

1.2.1 Connection survey

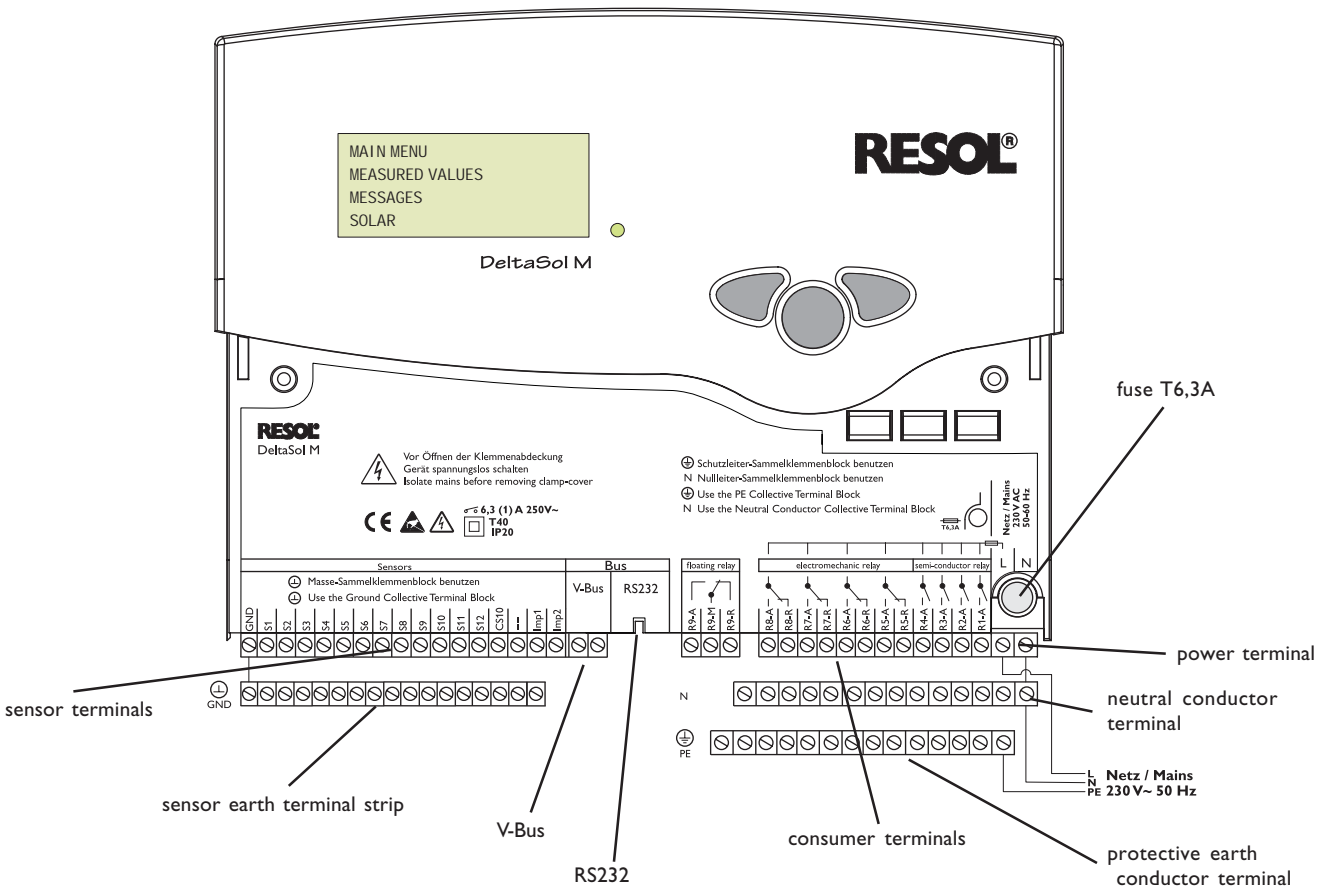

1.2.2 Sensors

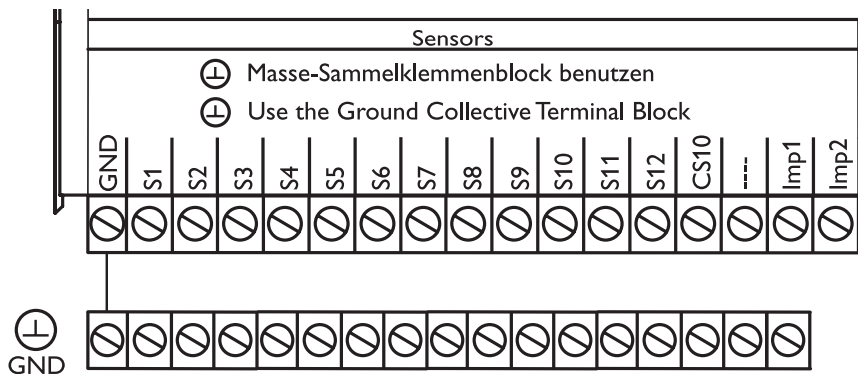

The controller is totally equipped with 15 sensor inputs. The earth connection for sensors is effected by the earth terminal strip (GND).

- The **temperature sensors** are connected to the terminals S1 ... S12 and GND (regardless of the polarity).
- The **irradiation sensor** (CS10) is to be connected to the terminals CS10 and GND (in consideration of the polarity!). The connection of the irradiation sensor with

the identification A (anode) is connected to their terminal CS10 and the connection with the identification K (cathode) is connected to the terminal GND.

- Two **flowmeters** RESOL V40 can be connected to the terminals Imp1, Imp2 and GND (regardless of the polarity).
- A **remote control** RESOL RTA11 can alternatively be connected to the terminal S10 (factory setting).

1.2.3 Actuators

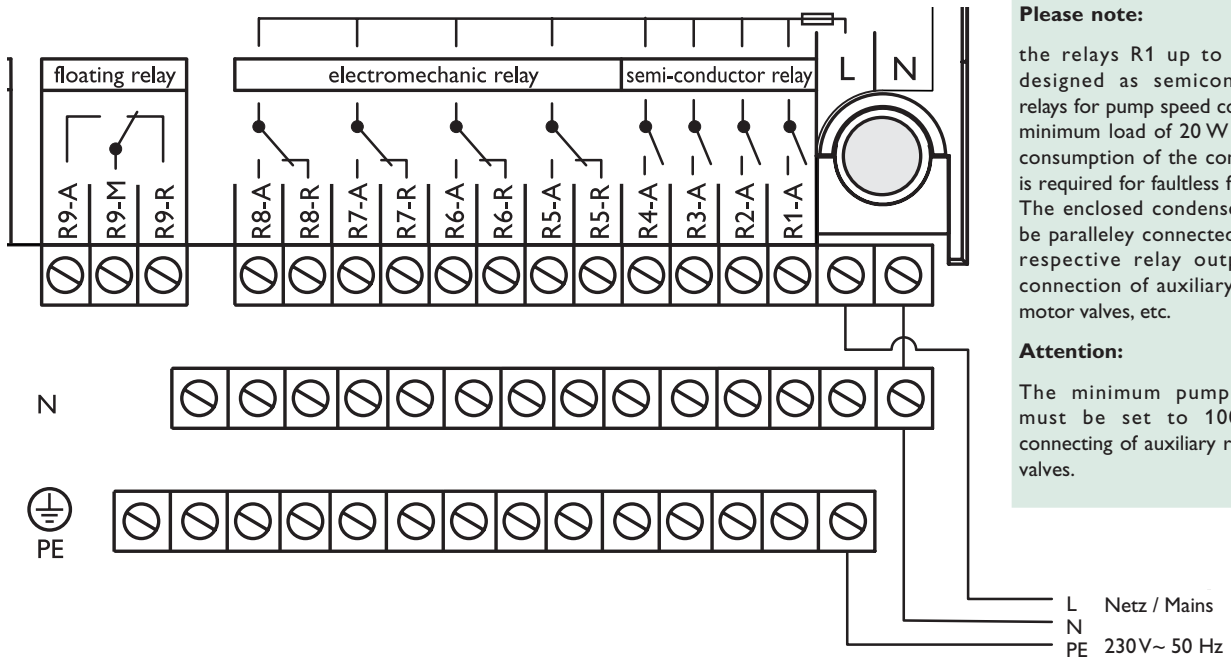

Please note:
the relays R1 up to R4 are designed as semiconductor relays for pump speed control. A minimum load of 20 W (power consumption of the consumer) is required for faultless function. The enclosed condenser must be parallely connected to the respective relay output for connection of auxiliary relays, motor valves, etc.

Attention:
The minimum pump speed must be set to 100% for connecting of auxiliary relays or valves.

The controller is totally equipped with 9 relays, to which the **consumer** (actuators), e. g. pumps, valves, mixer and auxiliary relays can be connected:

- **The relays R1...R4** are semi-conductor relays, also suited for pump speed control.
 - R1-A ... R4-A = normally open R1 ... R4
 - N = neutral conductor (collective terminal strip)
 - PE = protective earth conductor (collective terminal strip)

- **The relays R5 ... R8** are electromechanic relays with change-over contact.
 - R5-A ... R8-A = normally open R5 ... R8
 - R5-R ... R8-R = break contact R5 ... R8
 - N = neutral conductor (collective terminal strip)
 - PE = protective earth conductor (collective terminal strip)
- **The relay R9** ist ein potenzialfreies Relais mit Wechselkontakt:
 - R9-M = center contact R9
 - R9-A = normally open R9
 - R9-R = break contact R9

1.2.4 Bus

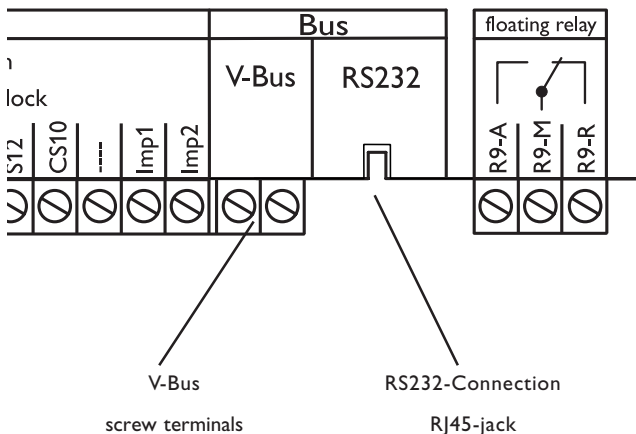

The controller is equipped with two bus interfaces for data transfer:

- 1.) The RESOL **VBus®** for data transfer with and energy supply of external modules. The connection is effected at the two terminals marked "VBus®" (any polarity). One or more RESOL **VBus®** modules can be connected by this Data-Bus:
 - RESOL WMZ-M1, calorimeter module
 - RESOL large displays
 - RESOL HKM, modular heating circuit expansion
- 2.) The **RS232-interface** for direct connection to a PC. Measured values and parameter of the controller can be read out, adjusted processed and visualised by means of the evaluation tool RSC (**Resol Service Center Software**). The software makes possible a comfortable parametrisation and function control of the system.

1.2.5 Power supply

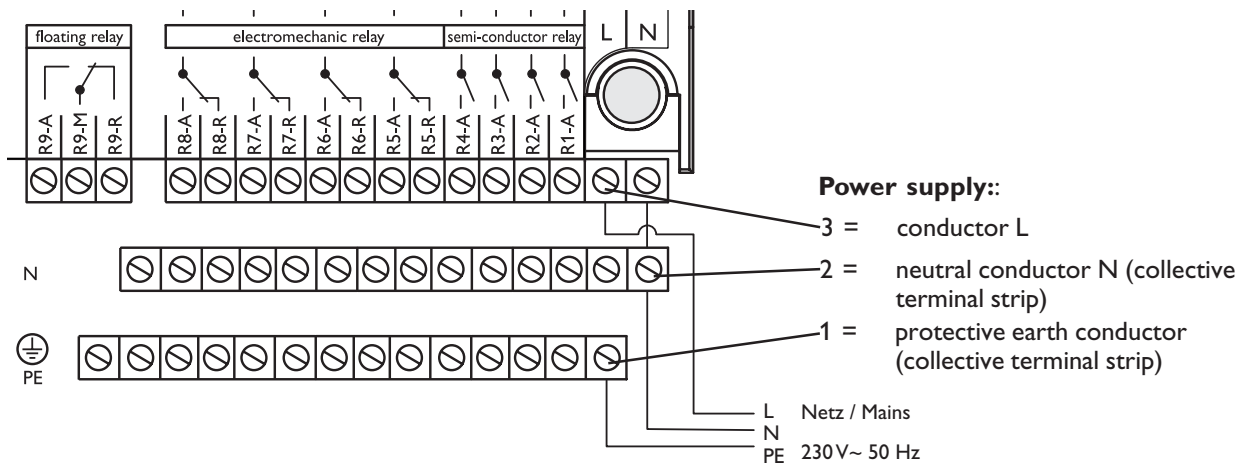

The power supply to the controller must be effected by an external power switch (last procedure) and the supply voltage must be 210 ... 250 Volt (50 ... 60 Hz). Flexible lines must be fixed at the housing or in a cable conduit (see tip

on page 5) by the enclosed strain relief clamps and respective screws.

2. Basic systems and hydraulic versions

The controller is programmed for 7 basic solar systems. Please see the following diagrams for connection of the sensors and relay allocation for the 7 basic systems as well as the most important versions. More examples can be found in the DeltaSol® M system book.

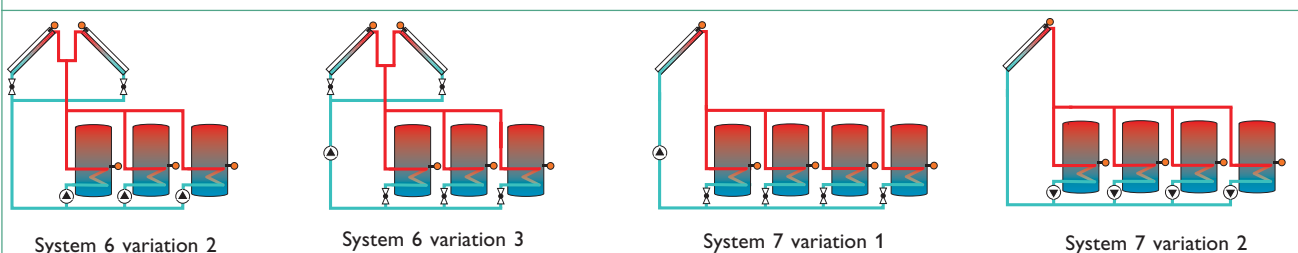
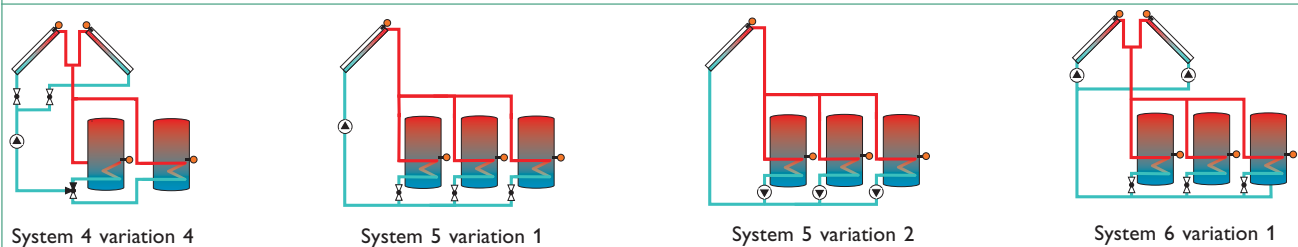
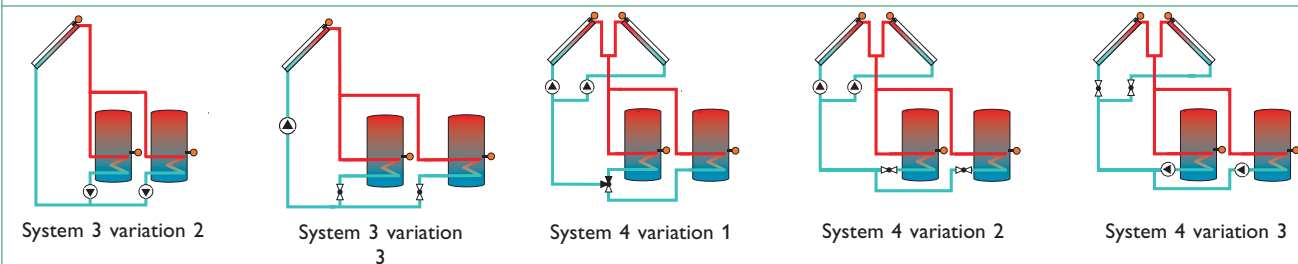
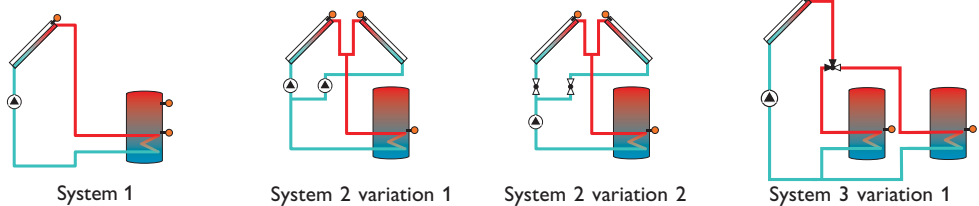

Example:

Relay allocation system 2		
relay 1	1	pump collector 1
	2	2-way-valve collector 1

- Explanation:
- 1.) System 2 / version 1, pump for collector 1 at relay output 1
 - 2.) System 2 / version 2, 2-way valve for collector 1 at relay output 1

The tabular survey shows the standard relay- and sensor allocation for the 7 basic systems with their hydraulic possibilities (see relay- and sensor allocation for the basic systems on page 8).

The controller is equipped with 10 thermostat functions, 5 additional temperature difference functions (DeltaT) and 5 timers. These functions are combined into function blocks which are allocated to the relay outputs.

Function	Function block				
	1	2	3	4	5
Thermostat	Thermostat 1 Thermostat 2	Thermostat 3 Thermostat 4	Thermostat 5 Thermostat 6	Thermostat 7 Thermostat 8	Thermostat 9 Thermostat 10
Difference function ΔT	ΔT 5	ΔT 6	ΔT 7	ΔT 8	ΔT 9
Timer function	Timer 1	Timer 2	Timer 3	Timer 4	Timer 5

2.1 Survey of the relay allocations

Relay allocation system 1	
Relay 1	Solar pump
Relay 2	External heat exchanger
Relay 3	Function block 1
Relay 4	Cooling function
Relay 5	Bypass, DVGW, Parallel relay
Relay 6	Function block 2, store charge controller, after-heating (HC)
Relay 7	Function block 3, mixer ON (HC)
Relay 8	Function block 4, mixer OFF (HC)
Relay 9	Function block 5, Error message, after-heating depression, pump (HC)

Relay allocation system 2		
Relay 1	1	Pump collector 1
	2	2-way valve collector 1
Relay 2	1	Pump collector 2
	2	2-way-valve collector 2
Relay 3	1	Function block 1 External heat exchanger
	2	Solar pump
Relay 4	Cooling function	
Relay 5	Bypass, DVGW, Parallel relay	
Relay 6	Function block 2, store charge controller, parallel relay	
Relay 7	Function block 3, mixer ON (HC)	
Relay 8	Function block 4, mixer OFF (HC)	
Relay 9	Function block 5, error message, after-heating depression, pump (HC)	

Relay allocation system 3		
Relay 1	1	Solar pump
	2	Solar pump, store 1
	3	Solar pump
Relay 2	1	external heat exchanger
	2	external heat exchanger
	3	2-way-valve store 1
Relay 3		Function block 1
Relay 4	1	3-way-valve store 1-2
	2	Solar pump store 2
	3	2-way-valve store 2
Relay 5		Bypass, DVGW, parallel relays
Relay 6		Function block 2, store charge controller, after-heating
Relay 7		Function block 3, mixer ON (HC)
Relay 8		Function block 4, mixer OFF (HC)
Relay 9		Function block 5, error message, after-heating depression, pump (HC)

Relay allocation system 5		
Relay 1	1	Solar pump
	2	Solar pump store 1
Relay 2	1	2-way-valve store 1
	2	Solar pump store 2
Relay 3		Function block 1 external heat exchanger
Relay 4	1	2-way-valve store 2
	2	Solar pump store 3
Relay 5	1	2-way-valve store 3
	2	-----
Relay 6		Function block 2, DVGW, parallel relays, Bypass store charge controller, after-heating (HK)
Relay 7		Function block 3, mixer on (HC)
Relay 8		Function block 4, mixer off (HC)
Relay 9		Function block 5, error message, after heating depression, pump (HC)

Relay allocation system 4		
Relay 1	1	Solar pump 1
	2	Solar pump 1
	3	2-way-valve collector 1
	4	2-way-valve collector 1
Relay 2	1	Solar pump 2
	2	Solar pump 2
	3	2-way-valve collector 2
	4	2-way-valve collector 2
Relay 3	1	Function block 1 external heat exchanger
	2	2-way-valve store 1
	3	Solar pump store 1
	4	Solar pump
Relay 4	1	3-way-valve store 1-2
	2	2-way-valve store 2
	3	Solar pump store 2
	4	3-way-valve store 1-2
Relay 5		Bypass, DVGW, parallel relays
Relay 6		Function block 2, store charge controller, after-heating
Relay 7		Function block 3, mixer on (HC)
Relay 8		Function block 4, mixer off (HC)
Relay 9		Function block 5, error message, after-heating depression, pump (HC)

Relay allocation system 6		
Relay 1	1	Solar pump 1
	2	Solar pump store 1
	3	2-way-valve collector 1
Relay 2	1	Solar pump 2
	2	Solar pump store 2
	3	2-way-valve collector 2
Relay 3		Function block 1, DVGW, parallel relay, Bypass external heat exchanger, after-heating (HK)
	3	Solar pump 3
Relay 4	1	2-way-valve store 1
	2	Solar pump store 3
	3	2-way-valve store 1
Relay 5	1	2-way-valve store 2
	2	2-way-valve collector 1
	3	2-way-valve collector 2
Relay 6	1	2-way-valve store 3
	2	2-way-valve collector 2
	3	2-way-valve store 3
Relay 7		Function block 3, mixer on (HC)
Relay 8		Function block 4, mixer off (HC)
Relay 9		Function block 5, error message, after-heating depression, pump (HC)

Relay allocation system 7		
Relay 1	1	Solar pump
	2	Solar pump store 1
Relay 2	1	2-way-valve store 1
	2	Solar pump store 2
Relay 3		Function block 1, DVGW, parallel relay, bypass, external heat exchanger, after-heating (HC)
Relay 4	1	2-way-valve store 2
	2	Solar pump store 3
Relay 5	1	2-way-valve store 3
	2	Solar pump store 4
Relay 6	1	2-way-valve store 4
	2	-----
Relay 7		Function block 3, mixer on (HC)
Relay 8		Function block 4, mixer off (HC)
Relay 9		Function block 5, error messages, after-heating depression, pump (HC)

2.2 Survey of sensor allocation

Sensor allocation system 1	
Sensor 1	Tcol
Sensor 2	Tst, DVGW
Sensor 3	Th 1, Tby, T-WT, T1 Δ T 5
Sensor 4	Th 2, T2 Δ T 5
Sensor 5	Th 3, T1 Δ T 6
Sensor 6	Th 4, T2 Δ T 6
Sensor 7	Th 5, T1 Δ T 7
Sensor 8	Th 6, T2 Δ T 7
Sensor 9	T1 WMZ1 (feed flow), T feed flow (HC) Th 7, T1 Δ T 8
Sensor 10	T2 WMZ1 (return flow) RTA11 (HC) Th 8, T2 Δ T 8
Sensor 11	T1 WMZ 2 (feed flow), T exterior (HC) Th 9, T1 Δ T 9
Sensor 12	T2 WMZ 2 (return flow) T-Sp (HC) Th 10, T2 Δ T 9
Impulse input 1	V40 WMZ 1
Impulse input 2	V40 WMZ 2

Sensor allocation system 2	
Sensor 1	Tcol
Sensor 2	Tst, DVGW
Sensor 3	Th 1, Tby, T-WT, T1 Δ T 5
Sensor 4	Th 2, T2 Δ T 5
Sensor 5	Th 3, T1 Δ T 6
Sensor 6	Tcol2, Th 4, T2 Δ T 6
Sensor 7	Th 5, T1 Δ T 7
Sensor 8	Th 6, T2 Δ T 7
Sensor 9	T1 WMZ1 (feed flow), T feed flow (HK) Th 7, T1 Δ T 8
Sensor 10	T2 WMZ1 (return flow), RTA11 (HK) Th 8, T2 Δ T 8
Sensor 11	T1 WMZ 2 (feed flow), T exterior (HK) Th 9, T1 Δ T 9
Sensor 12	T2 WMZ 2 (return flow), T-St (HK) Th 10, T2 Δ T 9
Impulse input 1	V40 WMZ 1
Impulse input 2	V40 WMZ 2

Sensor allocation system 3	
Sensor 1	Tcol
Sensor 2	Tst, DVGW
Sensor 3	Th 1, Tby, T-WT, T1 Δ T 5
Sensor 4	Tsp2u, Th 2, T2 Δ T 5
Sensor 5	Th 3, T1 Δ T 6
Sensor 6	Th 4, T2 Δ T 6
Sensor 7	Th 5, T1 Δ T 7
Sensor 8	Th 6, T2 Δ T 7
Sensor 9	T1 WMZ1 (feed flow), T feed flow (HC) Th 7, T1 Δ T 8
Sensor 10	T2 WMZ1 (return flow), RTA11 (HC) Th 8, T2 Δ T 8
Sensor 11	T1 WMZ 2 (feed flow), T exterior(HC) Th 9, T1 Δ T 9
Sensor 12	T2 WMZ 2 (return flow), T-St (HC) Th 10, T2 Δ T 9
Impulse input 1	V40 WMZ 1
Impulse input 2	V40 WMZ 2

Sensor allocation system 4	
Sensor 1	Tcol
Sensor 2	Tst, DVGW
Sensor 3	Th 1, Tby, T-WT, T1 Δ T 5
Sensor 4	Tst2, Th 2, T2 Δ T 5
Sensor 5	Th 3, T1 Δ T 6
Sensor 6	Tcol2, Th 4, T2 Δ T 6
Sensor 7	Th 5, T1 Δ T 7
Sensor 8	Th 6, T2 Δ T 7
Sensor 9	T1 WMZ1 (feed flow), T feed flow (HC) Th 7, T1 Δ T 8
Sensor 10	T2 WMZ1 (return flow), RTA11 (HC) Th 8, T2 Δ T 8
Sensor 11	T1 WMZ 2 (feed flow), T-exterior (HC) Th 9, T1 Δ T 9
Sensor 12	T2 WMZ 2 (return flow) T-St (HC) Th 10, T2 Δ T 9
Impulse input1	V40 WMZ 1
Impulse input 2	V40 WMZ 2

Sensor allocation system 5	
Sensor 1	Tcol
Sensor 2	Tst, DVGW
Sensor 3	Th 1, Tby, T-WT, T1 Δ T 5
Sensor 4	Tst2, Th 2, T2 Δ T 5
Sensor 5	Tst3, Th 3, T1 Δ T 6
Sensor 6	Th4, T2 Δ T 6
Sensor 7	Th 5, T1 Δ T 7
Sensor 8	Th 6, T2 Δ T 7
Sensor 9	T1 WMZ1 (feed flow), T feed flow (HC) Th 7, T1 Δ T 8
Sensor 10	T2 WMZ1 (return flow), RTA11 (HC) Th 8, T2 Δ T 8
Sensor 11	T1 WMZ 2 (feed flow), T-exterior (HC) Th 9, T1 Δ T 9
Sensor 12	T2 WMZ 2 (return flow), T-Sp (HC) Th 10, T2 Δ T 9
Impulse input 1	V40 WMZ 1
Impulse input 2	V40 WMZ 2

Sensor allocation system 6	
Sensor 1	Tcol
Sensor 2	Tst, DVGW
Sensor 3	Th 1, Tby, T-WT, T1 Δ T 5
Sensor 4	Tst, Th 2, T2 Δ T 5
Sensor 5	Tst3
Sensor 6	Tcol2
Sensor 7	Th 5, T1 Δ T 7
Sensor 8	Th 6, T2 Δ T 7
Sensor 9	T1 WMZ1 (feed flow), T feed flow (HC) Th 7, T1 Δ T 8
Sensor 10	T2 WMZ1 (return flow), RTA11 (HC) Th 8, T2 Δ T 8
Sensor 11	T1 WMZ 2 (feed flow), T exterior (HC) Th 9, T1 Δ T 9
Sensor 12	T2 WMZ 2 (return flow), T-Sp (HC) Th 10, T2 Δ T 9
Impulse input 1	V40 WMZ 1
Impulse input 2	V40 WMZ 2

Sensor allocation system 7	
Sensor 1	Tcol
Sensor 2	Tst, DVGW
Sensor 3	Th 1, Tby, T-WT, T1 Δ T 5
Sensor 4	Tst2, Th 2, T2 Δ T 5
Sensor 5	Tst3
Sensor 6	Tst4
Sensor 7	Th 5, T1 Δ T 7
Sensor 8	Th 6, T2 Δ T 7
Sensor 9	T1 WMZ1 (feed flow), T feed flow (HC) Th 7, T1 Δ T 8
Sensor 10	T2 WMZ1 (return flow), RTA11 (HC) Th 8, T2 Δ T 8
Sensor 11	T1 WMZ 2 (feed flow), T exterior (HC) Th 9, T1 Δ T 9
Sensor 12	T2 WMZ 2 (return flow), T-St (HC) Th 10, T2 Δ T 9
Impulse input 1	V40 WMZ 1
Impulse input 2	V40 WMZ 2

3. Sensors

3.1 Temperature sensors



Note:

In order to avoid overvoltage damages at collector sensors (e.g. from local lightning storms), we recommend to install the overvoltage protection **RESOL SP1**.



Precision-platin sensors type PT1000 (FKP and FRP) are used for the controller RESOL DeltaSol M.

Depending on the individual solar system, the RESOL product range contains 3 different sensor types: sensors with immersion sleeves, flatscrew sensors and cylindrical clip-on sensors. The sensor types FK and FR have the same electrical features and are available in the same models, they only differ in the connecting cable:

FK: 1,5 m weather- and temperature resistant silicone cable for temperatures between -50 °C ... +180 °C, mostly used for collectors.

FR: 2,5 m PVC cable for temperatures between -5 °C ... +80 °C, mostly used for stores.

Make sure that all electrical works are carried out according to the relevant local and IEE-regulations. The sensor cables carry low voltages and they must not run together in a cable conduit with cables carrying higher voltages than 50Volts. When using longer cables or cable conduits, please use screened cables. The sensor cables can be lengthened up to 100 m, but the cross section must be 1,5 mm² (or 0,75 mm² up to a cable length of 50 m); screened cables should be used preferably. The sensors must not be in direct contact with water; please always use immersion sleeves.

3.2 Irradiation sensor



The solar cell is used for recording of the momentary irradiation intensity. The short-circuit flow rises with the increase of irradiation intensity. The relation between the short-circuit flow and the irradiation intensity is directly proportional. The connecting cord can be expanded up to 100 m.

3.3 Flowmeter



The RESOL V40 is a measuring instrument with contact donator for recording the flow of water or water/glycol mixtures and is used in combination with the calorimeter integrated into the DeltaSol M. After flow of a specific volume, the V40 sends an impulse to the calorimeter. The used heat amount is measured by these impulses and a measured temperature difference with the help of pre-defined parameters (glycol type, concentration, heat capacity, etc.).

3.4 Remote control



The remote control RTA11 allows a comfortable adjustment of the heating curve of the controller from the living room. The rise of the heating curve causes an increase in flow temperature, a fall causes a decrease. The remote control additionally contains the functions "heating circuit-off" and "fast heating-up".

3.5 Outdoor temperature sensor



The outdoor temperature sensor FAP12 is suitable for mounting on even surfaces and it is needed for DeltaSol M's weather controlled heating circuit. The sensor has a weather resistant housing.

4. Basics of operation

4.1 Operating devices and display

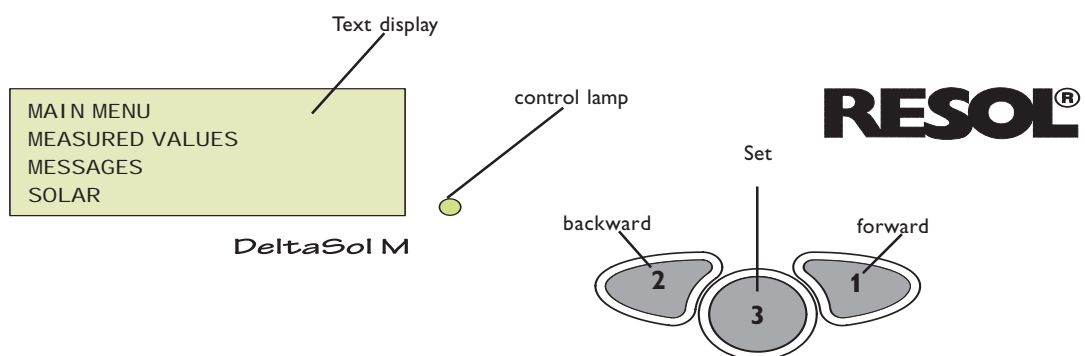

The controller is only operated by the 3 pushbuttons beside the display. The forward-button (1) is used for scrolling forward through the menu or to increase the adjustment values. The backward-button (2) is accordingly used the other way round. Button 3 is used for selection of the menu lines and confirmation.

- Please select your requested menu by the buttons 1 and 2.
- Shortly press button 3, the selected submenu is now shown on the display. By pressing the "back"-button, the display returns to the former menu level.
- Press buttons 1, 2 and 3 several times until the chosen menu line is reached.
- Shortly press button 3 in the relevant menu line for modification of adjustment values - "change value" appears on the display - adjust the requested value by

pressing the buttons 1 and 2 (for large intervals, please keep the button pressed).

- Shortly press button 3 in order to confirm the adjustment.
- Please reply to the following security request "Store?" by choosing "yes" or "no" (buttons 1 and 2) and confirm with button 3.
- **Note:**
If no input is made within 7 seconds in the modification mode, the controller automatically changes into the read-out mode. If no button is pressed for 4 minutes in the read-out menu, the display returns to the measured-values menu (in case of an existing message, the display changes into the message menu). If button 3 is pressed for 2 seconds, the display goes back to the main menu.

4.2 Control lamp



The controller is equipped with a red-/green control lamp. The following control and system status are signalled:

- green flashing: automatic operation, no malfunction
- red flashing: malfunction of the system

4.3 Menu structure

Note: The selectable adjustment values and options depend on the different functions and only appear on the display if they are available for the adjusted system parameter and cleared for the relevant user code.

User codes:

1. Expert-code 262 (factory setting):

All menus and adjustment values are shown and all adjustments can be changed.

2. User-code 077

The expert level is shown, the parameter access is restricted.

3. Customer-code 000

The expert level is blinded out, no change of parameter and balance values is possible.

The customer-code should be set to „000“.

The adjustment and control of the controller is effected by the menu. For first operation, the indication level is in the main menu. In the first line of each submenu you will find the option "return", by which the read-out can be reset by one menu level. In the following diagrams you will find the complete menu contents; as some of the menu points depend on a system, option or a message, in some cases not all of the shown text lines are indicated. "Main menu" is shown on the display in original position. A selection can be made between the following 9 menus:

- MAIN MENU
- | | |
|----|------------------|
| 1. | MEASURED VALUES |
| 2. | MESSAGES |
| 3. | SOLAR |
| 4. | SYSTEM |
| 5. | WIND |
| 6. | MANUAL OPERATION |
| 7. | USER CODE |
| 8. | EXPERT |

The clear text display shows a 4-line part of the selected menu.

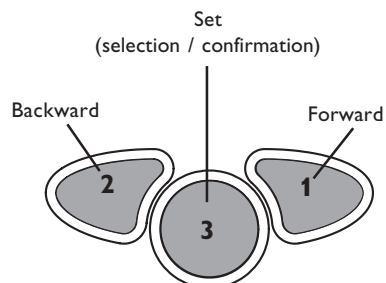

Tip:

After first commissioning, the measuring value menu is shown in the basic level. In order to simplify the operation, RETURN is not shown in the menu. If button 3 is shortly pressed, a change into the superior menu.

If button 3 is pressed longer than 3 seconds in all menus, the controller immediately returns into the menu "measured values".

4.4 Menu branch:

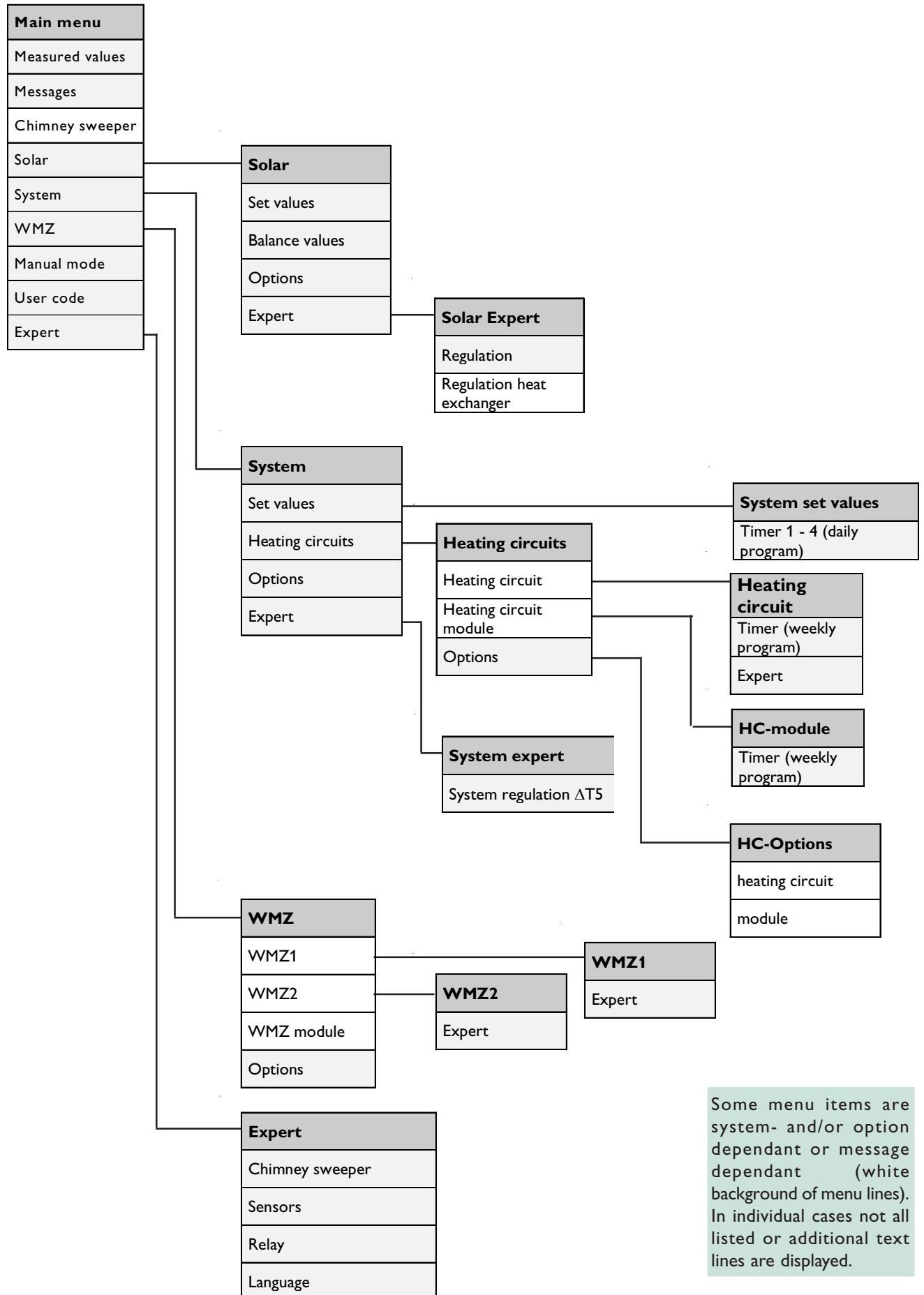

Some menu items are system- and/or option dependant or message dependant (white background of menu lines). In individual cases not all listed or additional text lines are displayed.

5. Functions and options

Pump speed control:

SOLAR/EXPERT/SOLAR CONTROL/TYPE

1. *NONE* pump speed control deactivated
2. *RISE* Standard-pump speed control (factory setting)
3. *PI-REG.* special pump speed control, more information on inquiry.

EXPERT/RELAY/MIN-SPEED1 (2,3,4)

The relays 1 to 4 are designed as semiconductors for usual standard pumps to adjust the pump speed.

The relative pump speed control is adjustable in 10% measures of the current temperature difference between collector- and store temperature. At which temperature difference the pump speed is increased can be adjusted by the parameter 'Rise'.

In some cases it is necessary to revise the factory setting of the minimum pump speed (30%).

Target temperature:

set *SOLAR/OPTIONS/TARGET TEMP* to „YES“
SOLAR/SOL.ADJUST.VAL/TCOLLSET

To set the pump speed independent from the collector temperature (to keep the collector temperature constant). Therefore the dependency of the temperature difference is detached. In order to adjust the set collector temperature use set value *TCOLLSET*.

Balancing function:

SOLAR/BALANCE VALUES

The controller possesses an integrated balancing function with its maximum temperatures, hours of operation of the relays and operation time since commissioning the controller can be asked.

These values can be reset except of the counter 'Operating days'.

Heat quantity balancing:

WMZ/WMZ1 (2)

The controller possesses 2 integrated heat amount counters which enable the 2 principles of heat quantity balancing functions. The information in Wh, kWh and MWh has to be added together.

set *WMZ/OPTIONS/WMZ1 (2)* to „YES“
set *WMZ/WMZ1 (2)/EXPERT/SEN.-FLOW* e.g. 1
set *WMZ/WMZ1 (2)/EXPERT/SEN.-RETURN* e.g. 1
set *WMZ/WMZ1 (2)/EXPERT/FLOW*
set *WMZ/WMZ1 (2)/EXPERT/RELAY*

Balancing without flowmeter RESOLV40

The balancing takes place as estimation with the aid of the difference between flow- and return temperature and the adjusted flow rate. The needed sensor must be assigned. Therefore an already used sensor can be applied. Through this its original function is not influenced. The balancing is realised when the selected output *RELAYS* is activated.

set *WMZ/OPTIONS/WMZ1 (2)* to „YES“
set *WMZ/WMZ1 (2)/EXPERT/SEN.-FLOW* e.g. "9"
set *WMZ/WMZ1 (2)/EXPERT/SEN.-RETURN* e.g. "10"
set *WMZ/WMZ1 (2)/EXPERT/FLOWMETER* to „YES“
set *WMZ/WMZ1 (2)/EXPERT/VOL/PULS* accordingly

Balancing with flowmeter RESOLV40

The balancing takes place with the assistance of the difference between the flow and return temperature and the volume flow, measured by the flowmeter. The needed sensor must be assigned. Therefore an already used sensor can be applied. Through this its original function is not influenced.

Antifreeze:

- 0: water
- 1: propylene glycol
- 2: ethylene glycol
- 3: Tyfocor® LS / G-LS

Antifreeze: Adjustment channel water / glykol

Adjustment range 20 ... 70 Vol %
factory setting 40 %

Hydraulics variants:*SOLAR/OPTIONS/LOADING***Menu-Language:***EXPERT/LANGUAGE***Function block:***ARRANGEMENT/OPTIONS*

Example functional switching circuit 1:

set *ARRANGEMENT/OPTIONS/THERMO.1* to „YES“.set *ARRANGEMENT/OPTIONS/ΔT-FUNC9* to „YES“.set *ARRANGEMENT/EXPERT/SEN-TH1* e.g. „4“.set *ARRANGEMENT/EXPERT/SEN1-ΔT5* e.g. „4“.set *ARRANGEMENT/EXPERT/SEN2-ΔT5* e.g. „5“.**ΔT-Function****(Function block 1 ... 5):***ARRANGEMENT/OPTIONS***Thermostat-Function****(Function block 1 ... 5):***ARRANGEMENT/OPTIONS***Maximum store temperature:*****T_{spmax}*:***Adjustment range 4 ... 95 °C**Factory setting 60 °C**Hysteresis 2 K (Factory setting)***Security switch-off of the store:***Fixed value 95 °C**Hysteresis = 2 K***Store blocked:**

The systems can be distinguished into pump- and ventil-driven systems. The adjustment takes place according to the survey of the system with its hydraulic variants (see page 8).

You find in the menu “languages“ different selectable languages.

Depending on the selected system or activated options there are up to 5 function blocks and they are composed of thermostat function, timer and difference functions (see page 9). With these, further components or functions e.g. solid fuel boiler, heater support and after heating can be realised.

These function blocks are assigned to different relays depending on the selected system (see survey of relay allocation). The needed sensor must be assigned. Therefore an already used sensor can be applied. Through this its original function is not influenced.

Function blocks' functions are linked together.

This option activates on if the adjusted switch-on temperature difference is exceeded and switches-off if the measured temperature difference falls below the adjusted switch-off temperature difference. The reference sensor is selectable in the expert menu.

This option switches on if the selected switch-on temperature is reached and switches-off if the selected switch-off temperature is exceeded. The reference sensor is selectable in the expert menu.

If the adjusted maximum temperature T_{spmax} is exceeded, the loading of the store is stopped. If the store cools down by more than 2 K, the store loading starts again.

If the cooling option is activated (e.g. collector cooling), the store is charged beyond the adjusted maximum temperature.

In order to avoid too high temperature in the store, the security switch-off of the store is additionally provided, which also blocks the store for cooling option. If a store temperature of 95 °C is reached, the security switch-off is activated.

A store is blocked if either the belonging sensor is defect or the security switch-off temperature is reached.

Collector security switch-off:***Tcolnot:****Adjustment range 110 ... 200 °C**Factory setting 130 °C**Hysteresis 10 K*

In case of high collector temperatures (dependant on e.g. system pressure or content of frost protection), the heat transport medium evaporates. That means, that a solar charge is no longer possible.

If the adjusted temperature threshold T_{colsec} is exceeded, the charge at each collector is suspended.

Note: if the option "collector cooling" is activated, the security switch-off temperature can not be adjusted lower than the maximum collector temperature (T_{colmax}).

Collector blocked:

A collector is considered to be blocked if either the sensor is defect or the security switch-off temperature is reached.

Solar collector blocked:***Tcolmin:****Adjustment range 10 ... 90 °C**Factory setting 10 °C**Hysteresis 2 K*

A collector for solar operation is considered to be blocked if the adjusted minimum temperature is not exceeded or the condition "collector blocked" is achieved.

Store charging:***ΔTon:****Adjustment range 1,5 ... 20,0 K**Factory setting 5,0 K****ΔToff:****Adjustment range 1,0 ... 19,5 K**Factory setting 3,0 K*

If the adjusted switch-on difference ΔT_{on} between collector and store is exceeded, the store is charged.

If this difference falls under the adjusted switch-off difference ΔT_{off} , the store is again charged.

The store charge is also suspended if the relevant store or collector is blocked (collector solar blocked) or if the store is at maximum limitation.

Cooling function:

The cooling function can be used in 1-store systems. If the store is at maximum limitation, the surplus energy in the collector can be derived. The pump output (provided that it is activated) is controlled with relative maximum pump speed.

Operation mode (switching conditions):

If the store is at maximum limitation and the switch-on temperature difference ΔT_{on} between collector and store is reached, the solar circuit (primary) and the cooling relay are operated.

If the switch-off temperature difference ΔT_{off} is underrun in this period, the solar circuit and the cooling relay are switched-off.

2-collector systems:

Only the collector circuit, which complies with the above described switch-on criteria, is operated in these systems.

Frost protection:

As soon as 4 °C are reached at the collector, the frost protection function operates the loading circuit between collector and 1st store in order to protect the medium in the loading circuit against freezing or coagulation.

If the collector temperature exceeds 5 °C, this function is switched-off.

If the 1st store is blocked in the system, this function is suspended.

The pump output is controlled with relative maximum pump speed (provided that the function is activated).

2-collector systems:

Only that circuit is operated, which complies with the above-mentioned switch-on conditions.

Chimney sweeper:

This function is used for activating a fixed relay condition if it is required. Because of that e.g. in case of flue gas measurement made by the chimney sweeper, the relays required for activation of the boiler can be switched-on. The required relay status is adjusted in the chimney sweeper menu (Expert/Chimney sweeper).

St2on ... St4off:

By means of this function, the respective store can be "removed" from the solar regulation, that means that it is no longer considered for solar charge. The temperature of the store is furthermore indicated but a sensor defect is no longer signalled.

Collector cooling function:***Tcolmax:***

Adjustment range 80 ... 160 °C

Factory setting 110 °C

Hysteresis 5 K

The collector cooling function starts if the adjusted maximum collector temperature is reached. If this temperature is underrun by 5 K, this function is switched-off.

The collector is cooled by the heat dissipation to the next free store, that means to a store which is not blocked. The numerically last store is not considered (swimming pool protection).

The pump output is controlled with relative maximum pump speed (provided that it is activated).

Note: it is not possible to adjust the maximum collector temperature (Tcolmax) higher than the collector security switch-off temperature.

2-collector systems:**2 separate collector circuits (2 pumps):**

Only that collector circuit, which needs to be cooled, is operated. If one store is charged right now by another collector, this charge is continued.

common collector circuits (1 pump):

The "pump speed" of the pump acts upon collector cooling. A parallelly operating store charge by the 2nd collector is subordinated.

Recooling:

Activating: $T_{st} \geq T_{stmax}$
Hysteresis 2 K

This function is used for keeping the system temperatures and consequently the thermal load as low as possible.

If all stores of a system have exceeded the maximum temperature, the loading circuit for 1st store is again operated in order to reduce the surplus energy from tubes and collector.

This "circulation" is again switched-off if the maximum store temperature is underrun by 2 K.

2-collector systems:

Both collector circuits are activated in a 2-collector system.

Combined with collector cooling function:

Activation: $(T_{st} - T_{col}) \geq 5 \text{ K}$
Deactivation: $(T_{st} - T_{col}) < 3 \text{ K}$

If the option "collector cooling" is activated in addition to the recooling function, the response action of the recooling function changes. The objective is now to dissipate the energy supplied by the collector cooling.

If the temperature at the collector decreases by 5 K below that of the store, the recooling function is activated and the loading circuit is again operated (for cooling of the store). If the difference between collector and store decreases below 3 K during that cooling period, the function is switched-off.

2-collector systems:

In a 2-collector system, the collectors are separately operated due to the above-described switch-on conditions.

DVGW:

The DVGW-function controls if the temperature at the given sensor (Sen-DVGW) exceeds a temperature of 60 °C.

If 60 °C are not reached up to DVGW start time, this function is activated in order to activate e.g. an after-heating.

The function is switched-off when 60 °C are reached at the relevant sensor or at midnight (reset).

If the relevant sensor does not work, this function is suspended.

CS-Bypass:

CS-Bypass:
Adjustment range 100 ... 500 W/m²
Factory setting 200 W/m²

If the irradiation exceeds the adjusted value CS-bypass, so that the collector circuit is operated.

It is switched-off if the irradiation falls 2 minutes below the value CS-bypass.

The collector circuit is operated with minimum pump speed.

2-collector systems:

If a loading of the stores is effected in these systems, the function is switched-off.

Tube collector special function:

This function considers the "unfavourable" sensor positioning of tube collectors.

This function operates within a given time slot ("tube-start" and "tube-end"). It activates the collector circuit every 30 minutes at collector standstill (adjustable by parameter "tube collector") for 30 seconds (adjustable by the parameter "tube-run") in order to compensate the delayed temperature measurement.

If the collector sensor is faulty or the collector is blocked, this function is suspended or switched-off.

The collector circuit is operated with minimum pump speed control.

2-collector systems:**2 separate collector circuits (2 pumps):**

Both collectors are independantly operated by this function.

If store charge is effected by one collector, the other one is nevertheless operated according to the adjusted standstill time.

common collector circuit (1 pump):

If store charge is effected by one collector, the other one is nevertheless operated according to the adjusted standstill time. That means, that minimum pump speed is adjusted and a possible pump speed is ignored by the controller.

Bypass:

Activation: $T_{by} \geq T_{sp} + 2,5 \text{ K}$

Deactivation: $T_{by} < T_{sp} + 1,5 \text{ K}$

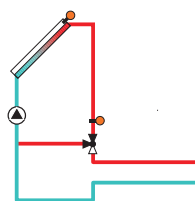
Valve version:

In order to avoid energy emission from the store when starting the store charge, this function provides that the cold medium from the lead is passed the store via bypass.

If the lead is warm enough, the store charge can start.

The bypass relay is operated if the relevant sensor is 2,5 K higher than store charge temperature and the irradiation condition for store charge (see store charge) is achieved.

This function is switched-off if the temperature difference is lower than 1,5 K.

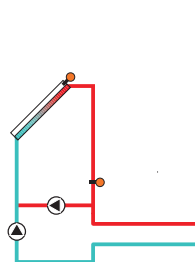
Pump version:

A bypass pump is advanced to the collector pump in this version.

The bypass pump is at first operated in case of a possible store charge.

If the above-mentioned switch-on condition is achieved, the bypass pump is switched-off and the collector circuit pump is activated.

This version is only available for 1-collector systems.

External heat exchanger:

Activation: $T_{HE} \geq T_{st} + HE-\Delta T_{on}$ (collector circuit active) Factory setting: $HE-\Delta T_{on} = 5,0 \text{ K}$

Deactivation: $T_{HE} < T_{st} + HE-\Delta T_{off}$
Factory setting: $HE-\Delta T_{off} = 3,0 \text{ K}$

This function is used for reasonable linking of charge circuits, which are separated by an external heat exchanger (different heat transfer media).

The heat exchanger relay is operated if the relevant sensor shows a temperature which is by the adjusted value "heat exchanger DeltaTon" higher than the store temperature and the switch-on conditions for store charge (see "store charge") are achieved.

The relay is switched-off if this temperature difference falls below the adjusted switch-off difference $WT-\Delta T_{off}$.

In contrast to the bypass function, a differential regulation between T_{WT} and T_{st} can be realised by means of the heat exchanger relay.

In systems in which stores are equipped with loading pumps, the relay "external heat exchanger" controls the primary circuit pump.

Parallel relay:

If the solar circuit pump(s) is/are switched-on, this relay is parallelly activated.

In 2-collector systems which are working with 2 pumps it is activated if one of the 2 pumps are switched-on.

Store loading:

Activation:

Temperature sensor Th3 and sensor Th4 $\leq Th3_{on}$

Deactivation:

Temperature sensor Th3 and sensor Th4 $\geq Th3_{off}$

In order to realize the after-heating of a store within a certain store volume (zone), this function needs 2 sensors to control switch-on and switch-off level.

The switching-on and -off temperatures of the "free" thermostat 3 (Th3 on and Th3 off) are regarded as reference parameters. The reference sensors can be activated by Sen-Th3 and Sen Th-4.

If the measured temperatures at both reference sensors fall below the adjusted switching threshold $Th3_{on}$, one relay is switched-on. It is switched-off if the temperature at both sensors is higher than $Th3_{off}$.

If one of the two sensors is faulty, the store loading is suspended or broken off.

In addition to that, this option can temporally be blocked by means of the daily timer 2.

After-heating-depression:

This function is activated if a previously selected solar store (parameter: "Hz-suppr.St" in the menu Solar - Expert) is charged.

Solar means that this store loading is only made for energy measurement and not for cooling purpose or something else.

Message relay (Error report):

This function is activated if a fault is realized by the controller. In that case the message relay is activated (e.g. for pilot lamps)

Possible errors are:

- Sensor defect
- Real-time-clock defect
- Ram (EEPROM) defect

Please note that a message made by the plausibility control does not activate a relay.

System warning "nocturnal circulation":

This message is shown if the collector temperature between 11 p.m. and 5.00 a.m. is higher than 40 °C or a store is charged.

In order to avoid release of this message due to short-term disturbances, the above-mentioned release condition must be given for 1 minute.

System warning "ΔT too high":

This message is shown if a solar loading is effected for a period of 20 minutes with a difference higher than 50 K.

Heating circuit:

The controller enables to control two independent weather controlled heating circuits. One heating circuit can be controlled by the internal heating circuit function and one further by the external module RESOL HKM2.

Internal heating circuit control:

set `ARRANGEMENT/HEAT.CIRCUITS/OPTIONS/HEAT.CURC.` to „YES“

Tflow: The value **temperature feed flow** shows the current flow temperature of the heating medium.

Toutd.: The value **outside temperature** shows the outside temperature influenced by the weather.

Flow Set: The measured outside temperature and the adjusted heating curve result the set flow temperature. Onto this the correction value of remote control as well as the day correction or night correction will be added.

Set flow temperature = heating curve temperature + remote control + (day correction or night correction).

For the case that the set flow temperature is higher than the adjusted flow maximum temperature, the set flow temperature is equate with the flow maximum temperature.

Night corr.: Adjustment channel for the night correction of the heating circuit. For the night correction daily timer 1 with its 3 time frames (see below) can be adjusted. The set flow temperature will be dropped by the adjusted temperature difference.

Adjustment range: -20 ... +30 K
Factory setting: -5 K

Adjustment range: -5 ... +45 K
 Factory setting: 5 K

Day corr.: Adjustment channel for the day correction of the heating circuit. The day correction is always activating outlying of the 3 time frames of the night correction. The set flow temperature will be dropped or risen by the adjusted temperature difference.

Adjustment range: 10 ... +100 °C
 Factory setting: 50 °C

Tflowmax: Adjustment channel for the maximum tolerable flow temperature of the heating circuit. By exceeding the maximum flow temperature the heating circuit will be switched off (the pump is deactivated and the mixer is closed).

Adjustment range: 0,3 ... 3,0
 Factory setting: 1,0

Heating curve: Dependence of the flow temperature, the outside temperature and the chosen heating curve.

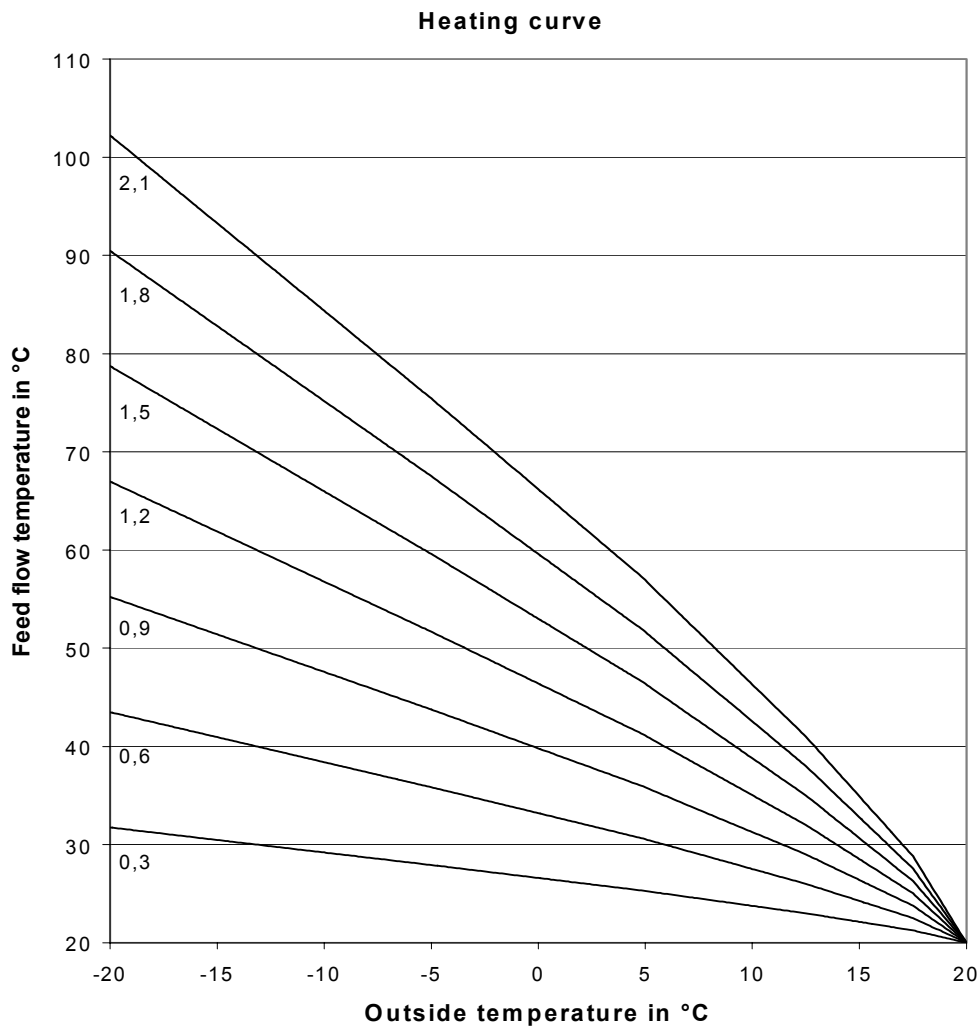

Adjustment range: 1 ... 20 s
Factory setting: 4 s

Adjustment range: 0 ... 40 °C
Factory setting: 20 °C

set ARRANGEMENT/HEAT.CIRCUITS/HEAT.CIRCUIT/STORE.PRIO. to „01“

Timer: (weekly clock timer)

Example: The night correction runs Tuesday from 22:00 to 6:00 and from 15:00 to 18:00, for it set t1-on to tue,22:00, t1-off to tue,6:00 and t2-on to tue,15:00 and t2-off to tue,18:00.
For the case that all time frames are set to 00:00 the night correction is deactivated and the heating circuit runs 7 days, 24h in the daily operation (factory setting).

set
ARRANGEMENT/HEAT.CIRCUITS/HEAT.CIRCUIT/EXPERT/SEN.FLOW
e.g. „2“
Factory setting: sensor 9

set
ARRANGEMENT/HEAT.CIRCUITS/HEAT.CIRCUIT/EXPERT/SEN.OUTDOOR
e.g. „15“
factory setting: sensor 11

set
ARRANGEMENT/HEAT.CIRCUITS/HEAT.CIRCUIT/EXPERT/AFT.-HEAT
to “YES”

set
ARRANGEMENT/HEAT.CIRCUITS/HEAT.CIRCUIT/EXPERT/S1(2) STORE
e.g. „2“
factory setting: Sensor 12

Mixer: By use of the mixer function it brings more the flow temperature and the set flow temperature in the line. Therefore the mixer is opened or closed accordingly the variation of the clock pulse. The mixer is controlled by the particular timing device. The break is calculated by the variation of the set- and actual value.

Summer: Adjustment channel of the summer activity. If the outside temperature exceeds the adjusted value the heating circuit switches off.

Store prio.: This function switches-off the heating circuit during after-heating. The option service water has to be activated and the boiler loading has to be realised by the DeltaSol® M.

The timer sets either the day correction or the night correction for the change of the set flow temperature is used. 21 different time frames can be set for the night correction. If one of the time frames is set 'active' the night correction is used. For the case that none of the them is in use the day correction brings more the flow temperature and set flow temperature in line. A time frame is activated when the current time is located between the switch-on and -off point.

Sen.flow: Adjustment channel for assigning the flow sensor. The needed sensor must be assigned. Therefore an already used sensor can be applied. Through this its original function is not influenced.

Sen.-outdoor.: Adjustment channel for assigning the outside temperature sensor. The needed sensor must be assigned. Therefore an already used sensor can be applied. Through this its original function is not influenced.

Note:
By additional use of the module RESOL HKM2 just 1 outside temperature sensor is needed. Since the 2 heating circuits control after the same outside temperature the following adjustments have to be made:

Aft.-heat.: If the store temperature falls below the flow temperature at + 4 K, the after heating switches-on (relais depending on system, see survey "allocation of relais"). It switches off if the store temperature oversteps the set flow temperature at + 14 K.

S1(2) store: Adjustment channel for assigning the store temperature sensors. The needed sensor must be assigned. Therefore an already used sensor can be applied. Through this its original function is not influenced. The related temperature Tsp is shown in the menu heating circuit.

set
ARRANGEMENT/HEAT.CIRCUITS/HEAT.CIRCUIT/EXPERT/MAN.CORR.
 to „YES“

Man.corr.:

The remote control enables a parallel movement of the heating curve (± 15 K). In addition the heating circuit can be switched off via the remote control. The remote control is optional and it is not included in the full kit.

The heating circuit can be switched off manually, if

- the remote control is set to the position "heating circuit off".

The heating circuit switches off automatically, if

- the adjusted flow maximum temperature is exceeded
- the outside temperature is higher than the adjusted summer temperature.
- the flow temperature sensor is defective.

Heating circuit switches-off means that the heating circuit pump is deactivated and the mixer is closed.

A rapid heating process of the heating circuit just take place via a remote control by adjusting it to "rapid heat process". It signifies that the heating circuit heats with the adjusted maximum flow temperature.

set
ARRANGEMENT/HEAT.CIRCUITS/HEAT.CIRCUIT/EXPERT/SEN.REMOTE
 e.g. „8“
 factory setting: Sensor 10

Sen.remote:

Adjustment channel for assigning the store temperature sensor. The needed sensor must be assigned. Therefore an already used sensor can be applied. Through this its original function is not influenced. The related remote controller correction Hand-cor. is shown in the menu heating circuit.

6. Commissioning:

6.1 Commissioning the controller

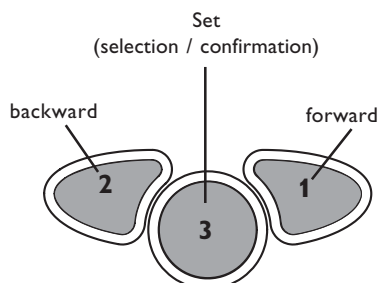

System 1: 1 collector	- 1 store
System 2: east-/west roof- collectors	- 1 store
System 3: 1 collector	- 2 stores
System 4: east-/west roof- collectors	- 2 stores
System 5: 1 collector	- 3 stores
System 6: east-/west roof- collectors	- 3 stores
System 7: 1 collector	- 4 stores

For first commissioning of the system, the main menu is shown on the display. The adjustments of the controller must perhaps be adapted to an existing system. The operation is effected by 3 pushbuttons:

1. Select language (*ARRANGEMENT/ADJ.VALUES*).
2. Set time (*ARRANGEMENT/ADJ.VALUES*).
3. Choose system (*SOLAR/OPTIONS/SYSTEM*).
4. Select options (*SOLAR/OPTIONS* and/or *ARRANGEMENT/OPTIONS*).
5. In the submenu of the menu *SOLAR* and *ARRANGEMENT*-check the controller's parameters and possibly change them.
6. Test the relays. For it switch the accordant relays manually in the menu *MANUAL OP.*
7. Finally switch-on the automatic operation for the relays in the menu *MANUAL OP.*

The new adjustments are automatically saved and are preserved even in case of power failure.

Please note:

The controller switches independently into the menu *MEASURED VALUES* or *MESSAGE MENU* if no adjustment or change is made within 4 minutes. Please select and shortly press the menu button *RETURN* in order to get back to the main menu. In case of adjustments and security inquiries without any change, the controller switches back to the respective menu after 7 seconds.

6.2 Adjustment for operation with solar cell

1. Set type of CS10 (*EXPERT/EXP-SENSORS*).
2. Calibrate CS10 (*EXPERT/SENSORS*).

For the calibration CS10 has to be disconnected!

7. Tipps for fault localization:



Please separate the controller from line voltage before opening the housing.

If the controller RESOL DeltaSol® M does not work faultlessly, please check the following items:

1. Power supply:

Check power supply if the controller if the control lamp for operation is expired. The controller is protected with 1 can fuse. This fuse can be replaced by removing the aperture and clamp cover (spare fuse is enclosed in accessory bag).

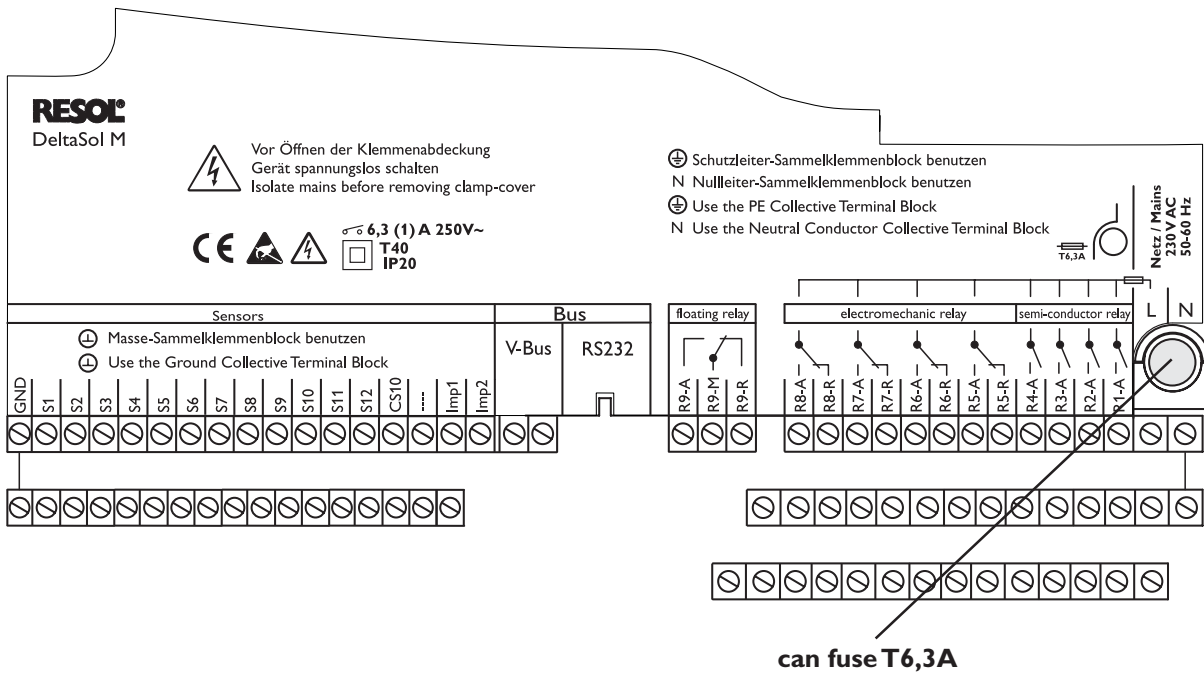

can fuse T6,3A

°C	Ω	°C	Ω
-10	961	55	1213
-5	980	60	1232
0	1000	65	1252
5	1019	70	1271
10	1039	75	1290
15	1058	80	1309
20	1078	85	1328
25	1097	90	1347
30	1117	95	1366
35	1136	100	1385
40	1155	105	1404
45	1175	110	1423
50	1194	115	1442

Resistance values of PT1000-sensors

2. Sensor defect:

The control lamp for operation flashes red and a message is shown on the display if there is a malfunction in the control circuit due to a sensor defect.

Sensor cable open means that a sensor cable is broken and

Sensor line short-circuit is shown for a hot-wired sensor cable with indication of the concerned sensor. In case of sensor defects, the sensor values can be checked.

Short-circuit: Short-circuit of a sensor cable with indication of the concerned temperature sensor. The error code -888.8 is shown on the display.

Cable break: Interruption of the sensor cable with indication of th concerned temperature sensor. The error code 888.8 is shown on the display.

Disconnected PT1000 temperature sensors can be checked with a resistance meter. Please check the resistances in the table opposite.

3. Messages:

If a malfunction occurs, a message is given on the display of the controller:

Message"!Sensor cable open" / "!Sensor cable short-c."
Control lamp flashes

Indication of a broken or hot-wired cable with indication of the concerned sensor.

Message"?Nocturnal circulation"

If the collector temperature between 11 p.m. and 5.00 a.m. is higher than 40 °C or the present temperature difference is higher than the switch-on temperature difference, this can indicate a heat return current (e.g. due to defect of non-return-valve).

This message is to be seen as warning and it should always be considered in relation to the outdoor temperature.

Message "!ΔT too high"

A store has been loaded for a period of at least 20 minutes with a ΔT of 50 K. Possible reasons are a defect pump, defect valve or a calcified heat exchanger.

Message "!EEPROM"

Indicated as malfunction during memory access. In this case, the controller is switched-off for a while and then switched-on again (please check all adjustments).

If the fault can be removed in this way, it has been a matter of data communication. But if the fault is still present, the controller should be returned to the manufacturer.

Message "!RTC":

Indicates a malfunction of the real-time-clock of the controller. Please switch-off the controller for a while and then switch it on again (please check the set time). If the fault is still present, all temporally controlled functions and options are disturbed. Emergency operation of the system is guaranteed, but the controller should be returned to the manufacturer.

4. Various:

Pump is overheated, but no heat transfer from collector to the store, feed flow and return flow are the same warm; perhaps also bubble in the lines.

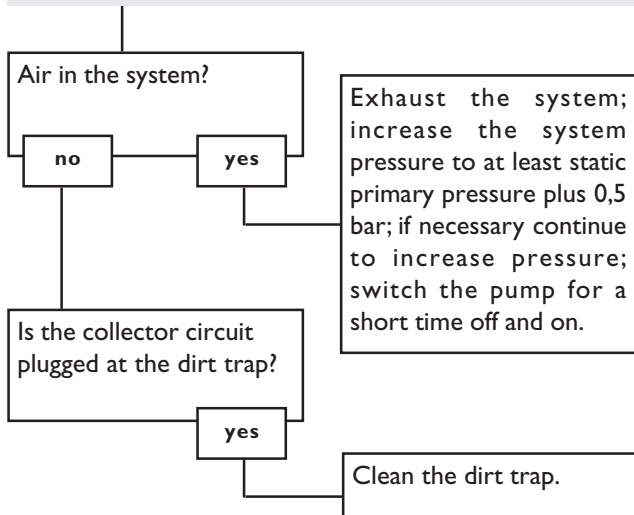

Pump starts for a short moment, switches-off, switches-on again, etc. ("controller jitting")

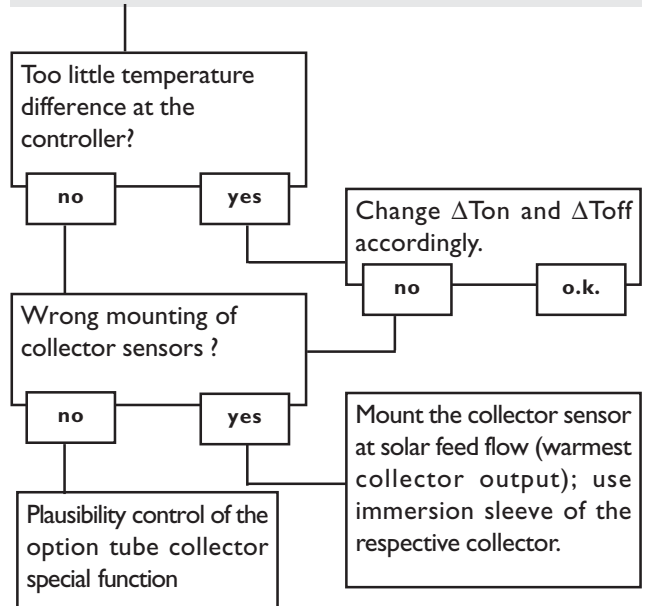

Pump starts up very late and stops working soon.

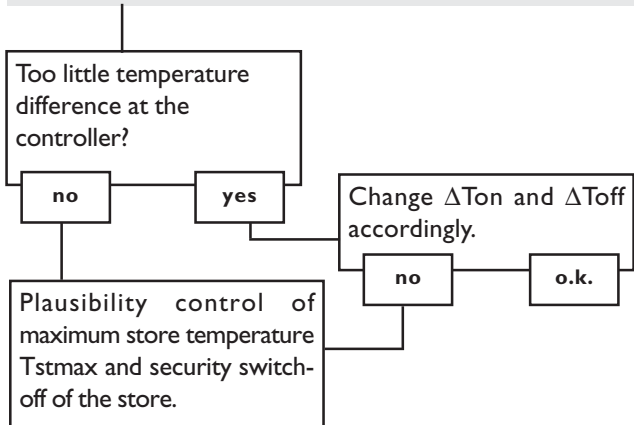

The temperature difference between store and collector increases enormously during operation; the collector circuit cannot dissipate the heat.

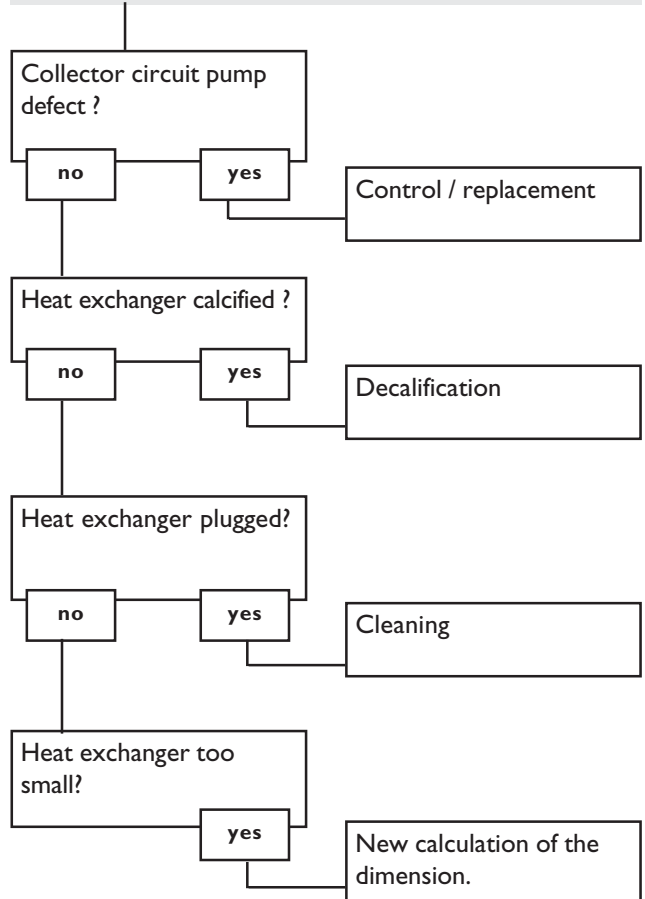

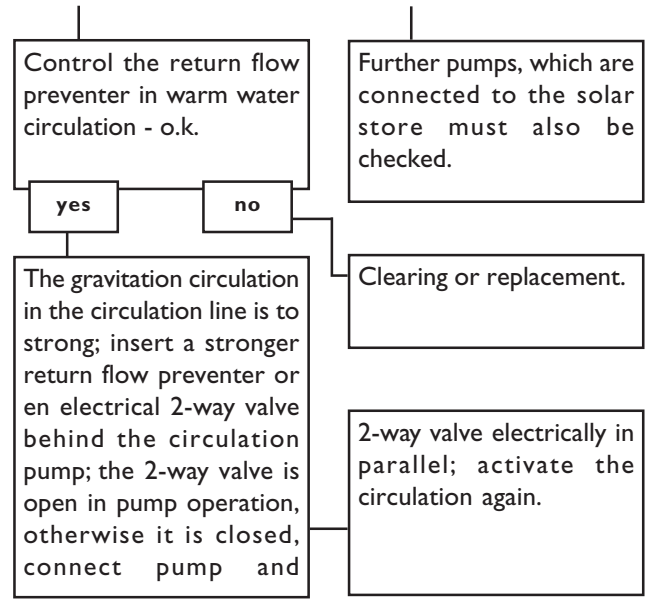
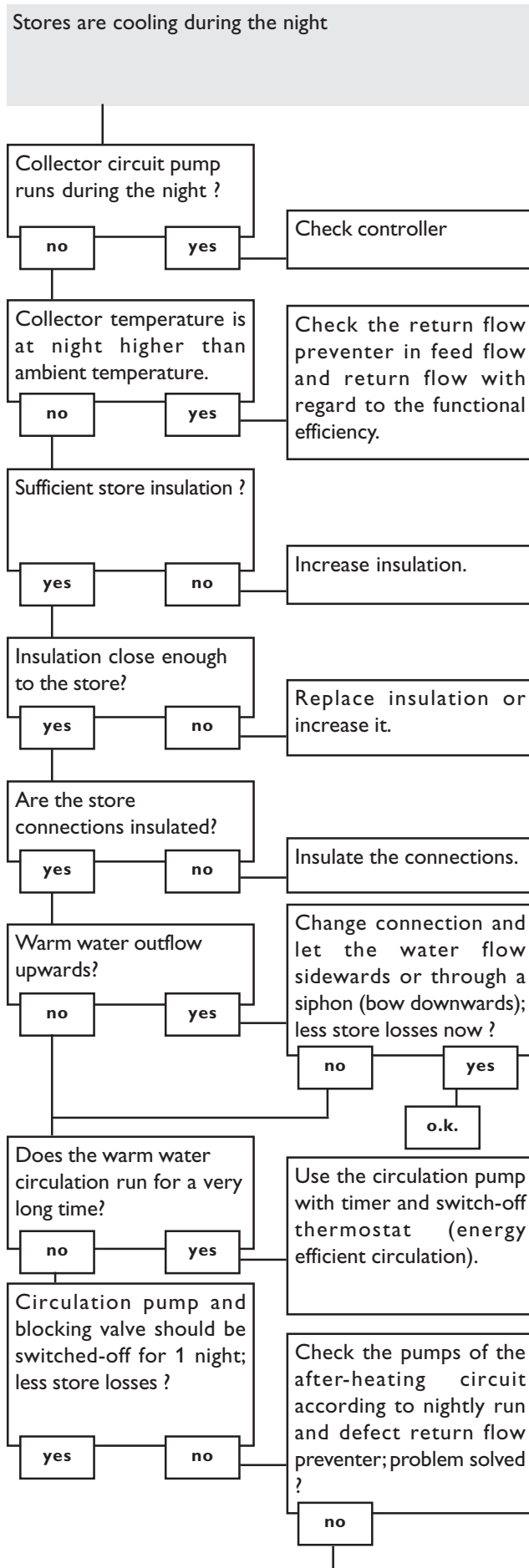

The solar circuit pump does not work, although the collector is obviously warmer than the store.

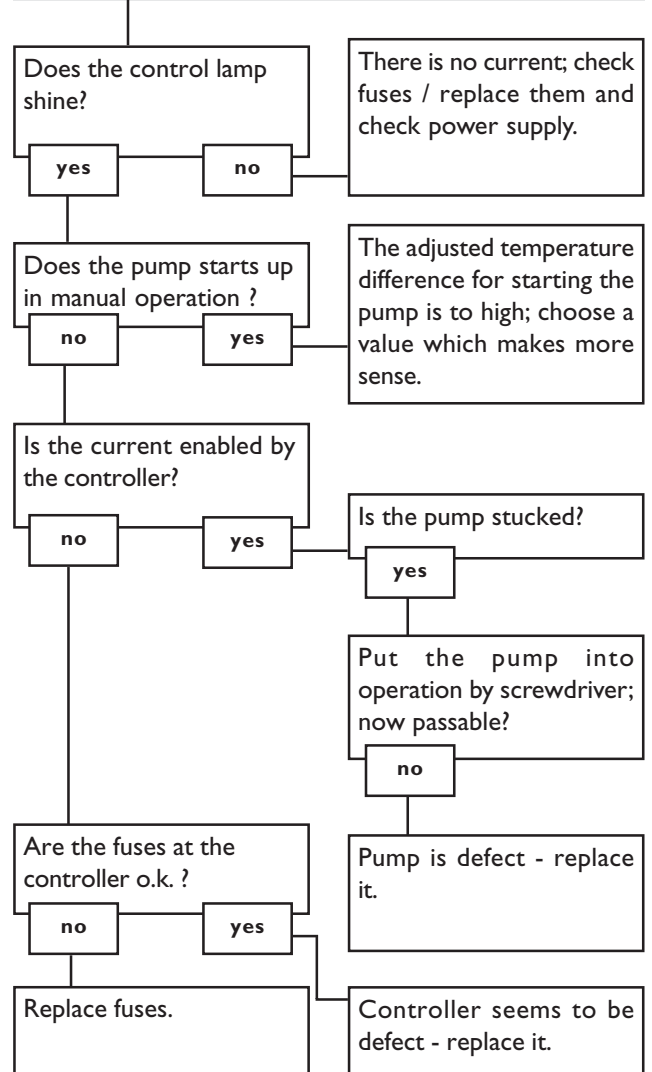

Your wholesaler:

Notes

Design and specifications are subject to change without notice.
Illustrations may differ slightly from production models.